

ETA-Danmark A/S
Kollegievej 6
DK-2920 Charlottenlund
Tel. +45 72 24 59 00
Fax +45 72 24 59 04
Internet www.etadanmark.dk



Authorised and notified according to Article 10 of the Council Directive 89/106/EEC of 21 December 1988 on the approximation of laws, regulations and administrative provisions of Member States relating to construction products

MEMBER OF EOTA

European Technical Approval ETA-09/0214

Trade name:	Drüeke & Springob Angle Brackets (type 1111, 1112, 1113, 1131, 1132, 1133)
Holder of approval:	Drüeke & Springob GmbH Bahnstrasse 19 57439 Attendorn - Kraghammer Tel. +49 02722 - 7771 Fax +49 02722 - 7922
Generic type and use of construction product:	Three-dimensional nailing plate (Angle Bracket for timber-to-timber connections)
Valid from: to:	2009-09-09 2014-09-09
Manufacturing plant:	Drüeke & Springob GmbH Bahnstrasse 19 57439 Attendorn - Kraghammer

This European Technical Approval contains: 19 pages including 2 annexes which form an integral part of the document



European Organisation for Technical Approvals

Europæisk Organisation for Tekniske Godkendelser

I LEGAL BASIS AND GENERAL CONDITIONS

1 This European Technical Approval is issued by ETA-Danmark A/S in accordance with:

- Council Directive 89/106/EEC of 21 December 1988 on the approximation of laws, regulations and administrative provisions of Member States relating to construction products¹⁾, as amended by Council Directive 93/68/EEC of 22 July 1993²⁾.
- Bekendtgørelse 559 af 27-06-1994 (afløser bekendtgørelse 480 af 25-06-1991) om ikrafttræden af EF direktiv af 21. december 1988 om indbyrdes tilnærmelse af medlemsstaternes love og administrative bestemmelser om byggevarer.
- Common Procedural Rules for Requesting, Preparing and the Granting of European Technical Approvals set out in the Annex to Commission Decision 94/23/EC³⁾.
- EOTA Guideline ETAG 015 *Three-dimensional nailing plates*, September 2002 edition.

2 ETA-Danmark A/S is authorized to check whether the provisions of this European Technical Approval are met. Checking may take place in the manufacturing plant. Nevertheless, the responsibility for the conformity of the products to the European Technical Approval and for their fitness for the intended use remains with the holder of the European Technical Approval.

3 This European Technical Approval is not to be transferred to manufacturers or agents of manufacturers other than those indicated on page 1, or manufacturing plants other than those indicated on page 1 of this European Technical Approval.

4 This European Technical Approval may be withdrawn by ETA-Danmark A/S pursuant to Article 5(1) of Council Directive 89/106/EEC.

- 1) Official Journal of the European Communities N° L40, 11 Feb 1989, p 12.
- 2) Official Journal of the European Communities N° L220, 30 Aug 1993, p 1.
- 3) Official Journal of the European Communities N° L 17, 20 Jan 1994, p 34.

5 Reproduction of this European Technical Approval including transmission by electronic means shall be in full. However, partial reproduction can be made with the written consent of ETA-Danmark A/S. In this case partial reproduction has to be designated as such. Texts and drawings of advertising brochures shall not contradict or misuse the European Technical Approval.

6 This European Technical Approval is issued by ETA-Danmark A/S in English. This version corresponds fully to the version circulated within EOTA. Translations into other languages have to be designated as such.

I SPECIAL CONDITIONS OF THE EUROPEAN TECHNICAL APPROVAL

1 Definition of product and intended use

Definition of the product

Drüeke & Springob angle brackets with and without rib are one-piece non-welded, face-fixed angle brackets to be used in timber to timber connections. They are connected to the timber elements by a range of profiled nails.

The angle brackets are made from pre-galvanized steel DX 51 D / Z 275 according to EN 10327:2004 with $R_e \geq 295 \text{ N/mm}^2$, $R_m \leq 360 \text{ N/mm}^2$ and $A_{80} \geq 22\%$ and are available with or without an embossed rib. Dimensions, hole positions and typical installations are shown in Annex A. Drüeke & Springob angle brackets are made from steel with tolerances according to EN 10143.

Intended use

The angle brackets are intended for use in making connections in load bearing timber structures, as a connection between a beam and a purlin, where requirements for mechanical resistance and stability and safety in use in the sense of the Essential Requirements 1 and 4 of Council Directive 89/106/EEC shall be fulfilled.

The connection may be with a single angle bracket or with an angle bracket on each side of the fastened timber member (see Annex A).

The static and kinematical behaviour of the timber members or the supports shall be as described in Annex B.

The wood members may be of solid timber, glued laminated timber and similar glued members, or wood-based structural members with a characteristic density from 290 kg/m^3 to 420 kg/m^3 . This requirement to the material of the wood members can be fulfilled by using the following materials:

- Structural solid timber classified to C14-C40 according to EN 338 / EN 14081,
- Glulam classified to GL24-GL36 according to EN 1194 / EN 14080,
- LVL according to EN 14374,
- Parallam PSL,
- Intrallam LSL,
- Duo- and Triobalken,
- Layered wood plates,
- Plywood according to EN 636

Annex B states the load-carrying capacities of the angle bracket connections for a characteristic density of 350 kg/m^3 . For timber or wood based material with a lower characteristic density than 350 kg/m^3 the load-carrying capacities shall be reduced by the k_{dens} factor:

$$k_{\text{dens}} = \left(\frac{\rho_k}{350} \right)^2$$

Where ρ_k is the characteristic density of the timber in kg/m^3 .

The design of the connections shall be in accordance with Eurocode 5 or a similar national Timber Code. The wood members shall have a thickness which is larger than the penetration depth of the nails into the members.

The angle brackets are primarily for use in timber structures subject to the dry, internal conditions defined by service classes 1 and 2 of Eurocode 5 and for connections subject to static or quasi-static loading.

The angle brackets can also be used in outdoor timber structures, service class 3, when a corrosion protection in accordance with Eurocode 5 is applied, or when stainless steel with similar or better characteristic yield and ultimate strength is employed.

Assumed working life

The assumed intended working life of the angle brackets for the intended use is 50 years, provided that they are subject to appropriate use and maintenance.

The information on the working life should not be regarded as a guarantee provided by the manufacturer or ETA Danmark. An “assumed intended working life” means that it is expected that, when this working life has elapsed, the real working life may be, in normal use conditions, considerably longer without major degradation affecting the essential requirements.

2 Characteristics of product and assessment

ETAG paragraph	Characteristic	Assessment of characteristic
	2.1 Mechanical resistance and stability*)	
6.1.1	Characteristic load-carrying capacity	See Annex B
6.1.2	Stiffness	No performance determined
6.1.3	Ductility in cyclic testing	No performance determined
	2.2 Safety in case of fire	
6.2.1	Reaction to fire	The angle brackets are made from steel classified as Euroclass A1 in accordance with EN 1350-1 and EC decision 96/603/EC, amended by EC Decision 2000/605/EC
	2.3 Hygiene, health and the environment	
6.3.1	Influence on air quality	No dangerous materials **)
	2.4 Safety in use	Not relevant
	2.5 Protection against noise	Not relevant
	2.6 Energy economy and heat retention	Not relevant
	2.7 Related aspects of serviceability	
6.7.1	Durability	The angle brackets have been assessed as having satisfactory durability and serviceability when used in timber structures using the timber species described in Eurocode 5 and subject to the conditions defined by service class 1 and 2
6.7.2	Serviceability	
6.7.3	Identification	

*) See page 5 of this ETA

**) In accordance with <http://europa.eu.int/comm/enterprise/construction/internal/dangsub/dangmain.htm> In addition to the specific clauses relating to dangerous substances contained in this European Technical Approval, there may be other requirements applicable to the products falling within its scope (e.g. transposed European legislation and national laws, regulations and administrative provisions). In order to meet the provisions of the EU Construction Products Directive, these requirements need also to be complied with, when and where they apply.

Safety principles and partial factors

The characteristic load-carrying capacities are based on the characteristic values of the nail connections and the steel plates. To obtain design values the capacities have to be divided by different partial factors for the material properties, the nail connection in addition multiplied with the coefficient k_{mod} .

According to EN 1990 (Eurocode – Basis of design) paragraph 6.3.5 the design value of load-carrying capacity may be determined by reducing the characteristic values of the load-carrying capacity with different partial factors.

Thus, the characteristic values of the load-carrying capacity are determined also for timber failure $F_{Rk,H}$ (obtaining the embedment strength of nails subjected to shear or the withdrawal capacity of the most loaded nail, respectively) as well as for steel plate failure $F_{Rk,S}$. The design value of the load-carrying capacity is the smaller value of both load-carrying capacities.

$$F_{Rd} = \min \left\{ \frac{k_{mod} \cdot F_{Rk,H}}{\gamma_{M,H}}; \frac{F_{Rk,S}}{\gamma_{M,S}} \right\}$$

Therefore, for timber failure the load duration class and the service class are included. The different partial factors γ_M for steel or timber, respectively, are also correctly taken into account.

2.1 Mechanical resistance and stability

See annex B for the characteristic load-carrying capacity in the different directions F_1 to F_5 .

The characteristic capacities of the angle brackets are determined by calculation assisted by testing as described in the EOTA Guideline 015 clause 5.1.2. They should be used for designs in accordance with Eurocode 5 or a similar national Timber Code.

Threaded nails (ringed shank nails) in accordance to EN 14592

In the formulas in Annex B the capacities for threaded nails calculated from the formulas of Eurocode 5 are used assuming a thick steel plate when calculating the lateral nail load-carrying capacity.

The load bearing capacities of the brackets has been determined based on the use of connector nails 4,0 x 40 mm in accordance with the German national approval for the nails.

The characteristic withdrawal capacity of the nails has to be determined by calculation in accordance with EN 1995-1-

1: 2004, paragraph 8.3.2 (head pull-through is not relevant):

$$F_{ax,Rk} = f_{ax,k} \times d \times t_{pen}$$

Where:

$f_{ax,k}$	Characteristic value of the withdrawal parameter in N/mm^2
d	Nail diameter in mm
t_{pen}	Penetration depth of the profiled shank including the nail point in mm, $t_{pen} \geq 31$ mm

Based on tests by Versuchsanstalt für Stahl, Holz und Steine, University of Karlsruhe, the characteristic value of the withdrawal resistance for the threaded nails used can be calculated as:

$$f_{ax,k} = 50 \times 10^{-6} \times \sigma_k^2$$

Where:

σ_k	Characteristic density of the timber in kg/m^3
------------	--

The shape of the nail directly under the head shall be in the form of a truncated cone with a diameter under the nail head which exceeds the hole diameter.

The design models allow the use of fasteners described in the table on page 9 in Annex A

No performance has been determined in relation to ductility of a joint under cyclic testing. The contribution to the performance of structures in seismic zones, therefore, has not been assessed.

No performance has been determined in relation to the joint's stiffness properties - to be used for the analysis of the serviceability limit state.

2.7 Related aspects of serviceability

2.7.1 Corrosion protection in service class 1 and 2.

In accordance with ETAG 015 the angle brackets are made from pre-galvanized steel DX 51 D / Z 275 according to EN 10327:2004 with $R_e \geq 295 N/mm^2$, $R_m \leq 360 N/mm^2$ and $A_{80} \geq 22\%$

3 Attestation of Conformity and CE marking

3.1 Attestation of Conformity system

The system of attestation of conformity is 2+ described in Council Directive 89/106/EEC (Construction Products Directive) Annex III.

- a) Tasks for the manufacturer:
 - (1) Factory production control,
 - (2) Initial type testing of the product,
- b) Tasks for the notified body:
 - (1) Initial inspection of the factory and the factory production control,
 - (2) Continuous surveillance

3.2 Responsibilities

3.2.1 Tasks of the manufacturer

3.2.1.1 Factory production control

The manufacturer has a factory production control system in the plant and exercises permanent internal control of production. All the elements, requirements and provisions adopted by the manufacturer are documented in a systematic manner in the form of written policies and procedures. This production control system ensures that the product is in conformity with the European Technical Approval.

The manufacturer shall only use raw materials supplied with the relevant inspection documents as laid down in the control plan⁴. The incoming raw materials shall be subject to controls and tests by the manufacturer before acceptance. Check of materials, such as sheet metal, shall include control of the inspection documents presented by suppliers (comparison with nominal values) by verifying dimension and determining material properties, e.g. chemical composition, mechanical properties and zinc coating thickness.

The manufactured components are checked visually and for dimensions.

The control plan, which is part of the technical documentation of this European Technical Approval,

⁴ The control plan has been deposited at ETA-Danmark and is only made available to the approved bodies involved in the conformity attestation procedure.

includes details of the extent, nature and frequency of testing and controls to be performed within the factory production control and has been agreed between the approval holder and ETA Danmark.

The results of factory production control are recorded and evaluated. The records include at least the following information:

- Designation of the product, basic material and components;
- Type of control or testing;
- Date of manufacture of the product and date of testing of the product or basic material and components;
- Result of control and testing and, if appropriate, comparison with requirements;
- Signature of person responsible for factory production control.

The records shall be presented to ETA Danmark on request.

3.2.1.1 Initial type testing of the product

For initial type-testing the results of the tests performed as part of the assessment for the European Technical Approval shall be used unless there are changes in the production line or plant. In such cases the necessary initial type testing has to be agreed between ETA Danmark and the notified body.

3.2.2. Tasks of notified bodies

3.2.2.1 Initial inspection of the factory and the factory production control

The approved body should ascertain that, in accordance with the control plan, the factory, in particular the staff and equipment, and the factory production control, are suitable to ensure a continuous and orderly manufacturing of the angle brackets with the specifications given in part 2.

3.2.2.2 Continuous surveillance

The approved body shall visit the factory at least twice a year for routine inspections. It shall be verified that the system of factory production control and the specified manufacturing processes are maintained, taking account of the control plan.

The results of product certification and continuous surveillance shall be made available on demand by the certification body to ETA Danmark. Where the provisions of the European Technical Approval and the control plan are no longer fulfilled, the certificate

of conformity shall be withdrawn by the approved body.

3.3 CE marking

The CE marking shall be affixed on each packaging of angle brackets. The initials "CE" shall be followed by the identification number of the notified body and shall be accompanied by the following information:

- Name or identifying mark of the manufacturer
- The last two digits of the year in which the marking was affixed
- Number of the European Technical Approval
- Name and size of product
- Number of the ETA Guideline (ETAG no. 015)
- Number of the EC Certificate of Conformity

4 Assumptions under which the fitness of the product for the intended use was favourably assessed

4.1 Manufacturing

Drüeke & Springob angle brackets are manufactured in accordance with the provisions of this European Technical Approval using the manufacturing processes as identified in the inspection of the plant by the notified inspection body and laid down in the technical documentation

4.2 Installation

The nailing pattern used shall be either the maximum or the minimum pattern as defined in Annex A.

The following provisions concerning installation apply:

The structural members – the components 1 and 2 shown in the figure on page 14 - to which the brackets are fixed shall be:

- Restrained against rotation. At a load F_4/F_5 , the component 2 is allowed to be restrained against rotation by the Angle brackets.
- Strength class C14 or better, see section 1 of this ETA
- Free from wane under the bracket.
- The actual end bearing capacity of the timber member to be used in conjunction with the bracket is checked by the designer of the structure to ensure it is not less than the bracket capacity and, if necessary, the bracket capacity reduced accordingly.
- The gap between the timber members does not exceed 3 mm.
- There are no specific requirements relating to preparation of the timber members.

The execution of the connection shall be in accordance with the approval holder's technical literature.

4.3 Maintenance and repair

Maintenance is not required during the assumed intended working life. Should repair prove necessary, it is normal to replace the angle bracket.



Thomas Bruun
Manager, ETA-Danmark

Annex A
Product details definitions

Table A.1 Materials specification

Bracket number	Bracket type	Thickness (mm)	Steel specification	Coating specification
1131	70x70x55	2,5	DX 51 D	Z 275
1111	70x70x55 with rib	2,5	DX 51 D	Z 275
1132	90x90x65	2,5	DX 51 D	Z 275
1112	90x90x65 with rib	2,5	DX 51 D	Z 275
1133	105x105x90	3,0	DX 51 D	Z 275
1113	105x105x90 with rib	3,0	DX 51 D	Z 275

Table A.2 Range of sizes

Bracket number	Bracket type	Height (mm)		Height (mm)		Width (mm)	
		vertical		horizontal			
1131	70x70x55	69	71	69	71	54	56
1111	70x70x55 with rib	69	71	69	71	51,5	56
1132	90x90x65	89	91	89	91	64	66
1112	90x90x65 with rib	89	91	89	91	59	66
1133	105x105x90	104	106	104	106	89	91
1113	105x105x90 with rib	104	106	104	106	83	91

Table A.3 Fastener specification

Nail type	Nail size (mm)		Finish
	Diameter	Length	
According to EN 14592			
Threaded nail	4,0	40	Electroplated zinc

In the load-carrying-capacities of the nailed connection in Annex B the capacities for threaded nails calculated from the formulas of Eurocode 5 are used assuming a thick steel plate when calculating the lateral nail load-carrying-capacity.

The load-carrying-capacities of the angle brackets have been determined based on the use of connector nails 4,0 x 40 mm in accordance with the German national approval for the nails.

The characteristic withdrawal capacity of the nails has to be determined by calculation in accordance with EN 1995-1-1:2004, paragraph 8.3.2 (head pull-through is not relevant):

$$F_{ax,Rk} = f_{ax,k} \times d \times t_{pen}$$

Where:

$f_{ax,k}$ Characteristic value of the withdrawal parameter in N/mm²

d Nail diameter in mm

t_{pen} Penetration depth of the profiled shank including the nail point in mm, $t_{pen} \geq 31$ mm

Based on tests by Versuchsanstalt für Stahl, Holz und Steine, University of Karlsruhe, the characteristic value of the withdrawal resistance for the threaded nails used can be calculated as:

$$f_{ax,k} = 50 \times 10^{-6} \times \rho_k^2$$

Where:

ρ_k Characteristic density of the timber in kg/m³

The shape of the nail directly under the head shall be in the form of a truncated cone with a diameter under the nail head which exceeds the hole diameter.

Drücke & Springob Angle Brackets

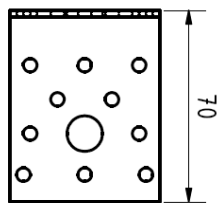
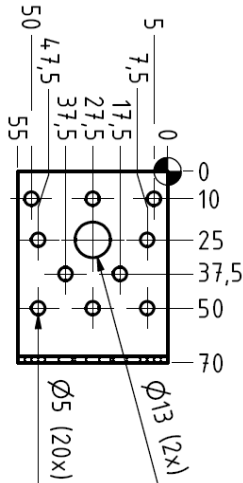

Figure A. 1 Dimensions of Angle Bracket 1131

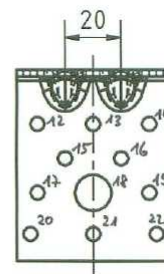
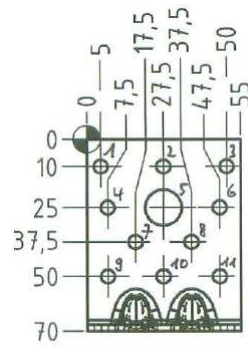

Figure A. 2 Dimensions of Angle Bracket 1111

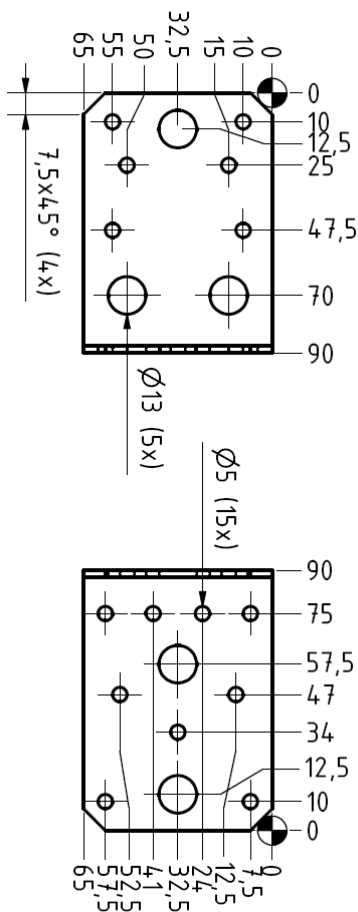

Figure A. 3 Dimensions of Angle Bracket 1132

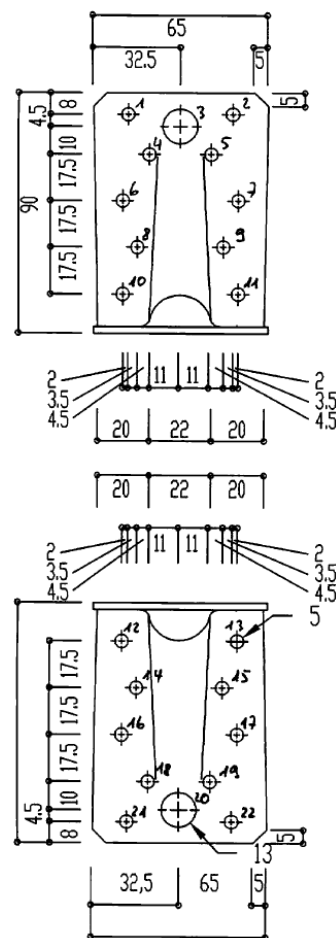

Figure A. 4 Dimensions of Angle Bracket 1112

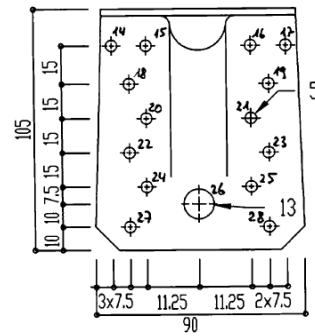
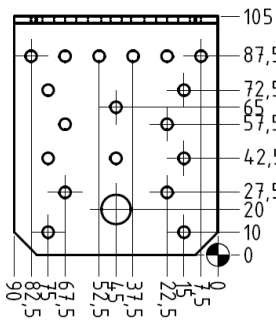
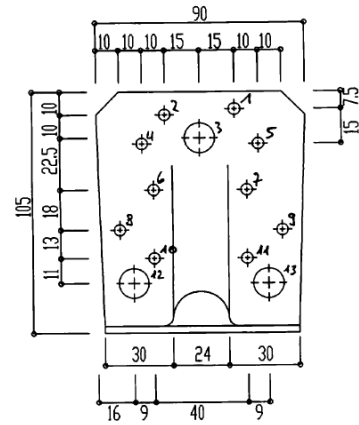
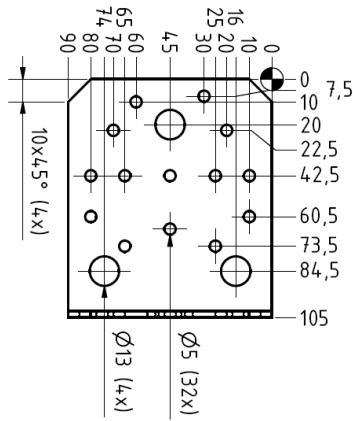

Figure A. 5 Dimensions of Angle Bracket 1133

Figure A. 6 Dimensions of Angle Bracket 1113

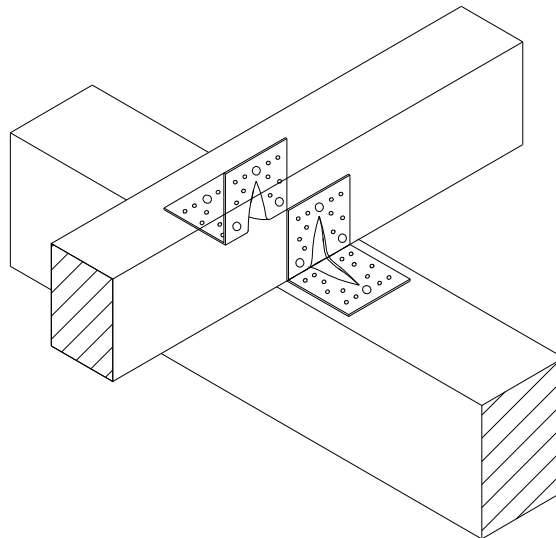

Figure A. 7 Typical installation

Nail Patterns – Angle Bracket 1131

LC 1 – column

Nails in hole number:

1,2,3 /

12,13,14,15,16,20,21,22

Art. Nr.: 1131

70x70x55x2,5

LF1

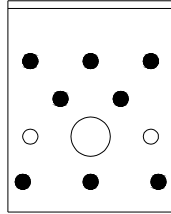
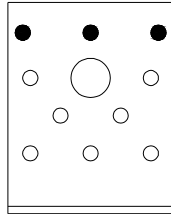

LC 1 – purlin, LC 2/3, LC 4/5

Nails in hole number:

1,2,3,7,8 /

12,13,14,15,16,20,21,22

LF2

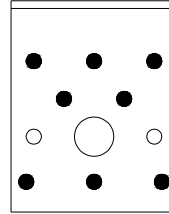
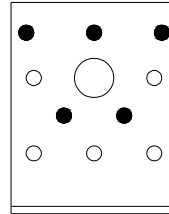

Nail Patterns – Angle Bracket 1111 with rib

LC 1 – column

Nails in hole number:

1,2,3 /

12,13,14,15,16,20,21,22

Art. Nr.: 1111

70x70x55x2,5 with Rib

LF1

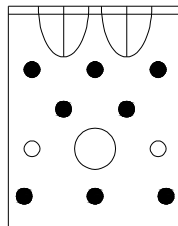
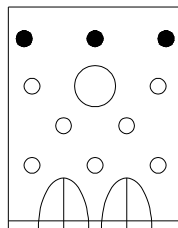

LC 1 – purlin, LC 2/3, LC 4/5

Nails in hole number:

1,2,3,7,8 /

12,13,14,15,16,20,21,22

LF2

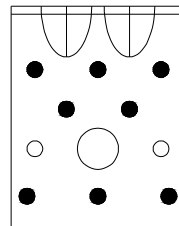
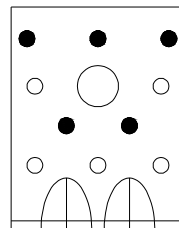

Nail Patterns – Angle Bracket 1132

LC 1 – column

Nails in hole number:

1,2 /

10,11,12,13,15,16,17,19,20,

Art. Nr.: 1132
90x90x65x2,5

LF1

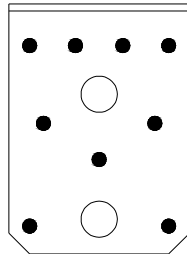
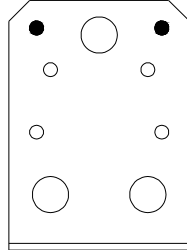

LC 1 – purlin, LC 2/3, LC 4/5

Nails in hole number:

1,2,4,5,6,7 /

10,11,12,13,15,16,17,19,20

LF2

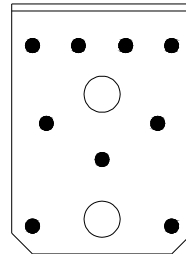
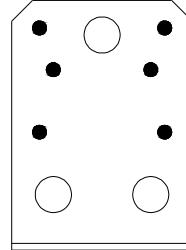

Nail Patterns – Angle Bracket 1112 with rib

LC 1 – column

Nails in hole number:

1,2 /

12,13,16,17,21,22

Art. Nr.: 1112
90x90x65x2,5 with Rib

LF1

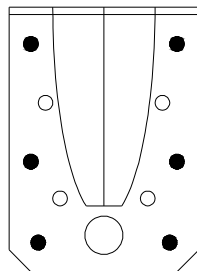
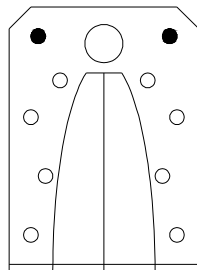

LC 1 – purlin, LC 2/3, LC 4/5

Nails in hole number:

1,2,4,6,7,8,9 /

12,13,16,17,21,22

LF2

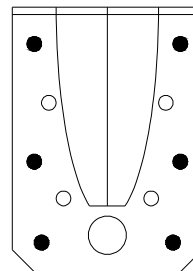
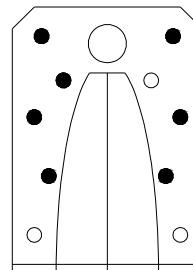

Nail Patterns – Angle Bracket 1133

LC 1 – column

Nails in hole number:

1,2,4,5,6,8,10 /

18,19,20,21,22,23,26,27,28,30,35,36

Art. Nr.: 1133
105x105x90x3,0
LF1

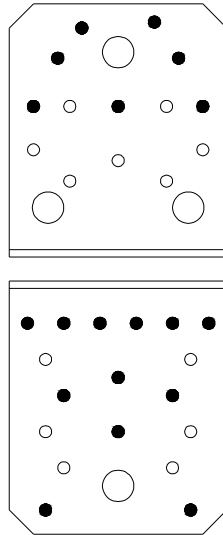

LC 1 – purlin, LC 2/3, LC 4/5

Nails in hole number:

1,2,4,5,6,8,10,11,12,14,15 /

18,19,20,21,22,23,26,27,28,30,35,36

LF2

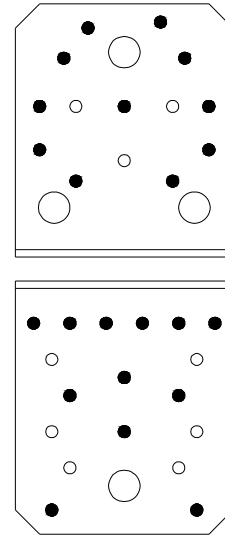

Nail Patterns – Angle Bracket 1113 with rib

LC 1 – column

Nails in hole number:

1,2,4,5,6,7 /

14,15,16,17,20,21, 27,28

Art. Nr.: 1113
105x105x90x3,0 with Rib
LF1

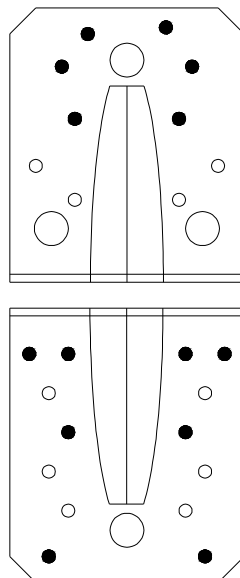

LC 1 – purlin, LC 2/3, LC 4/5

Nails in hole number:

1,2,4,5,6,7,8,9,10,11 /

14,15,16,17,20,21, 27,28

LF2

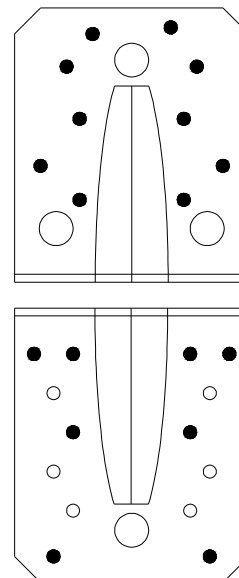

Annex B Characteristic load-carrying capacities

Definitions of forces, their directions and eccentricity

Forces - Beam to beam connection

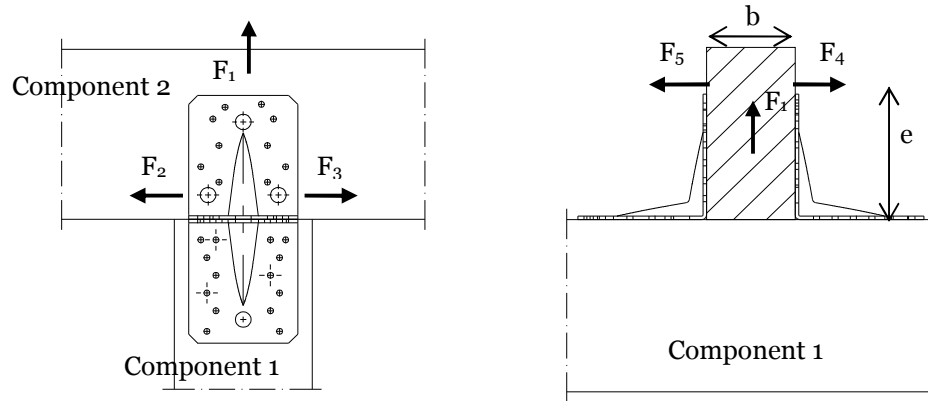

Fastener specification

Holes are marked with numbers referring to the nailing pattern in Annex A.

Double angle brackets per connection

The angle brackets must be placed at each side opposite to each other, symmetrically to the component axis.

Acting forces

- F_1 Lifting force acting along the central axis of the joint.
- F_2 and F_3 Lateral force acting in the joint between the component 2 and component 1 in the component 2 direction
- F_4 and F_5 Lateral force acting in the component 1 direction along the central axis of the joint. If the load is applied with an eccentricity e , a design for combined loading is required.

Single angle bracket per connection

Acting forces

- F_1 Lifting force acting in the central axis of the angle bracket. The component 2 shall be prevented from rotation. If the component 2 is prevented from rotation the load-carrying capacity will be half of a connection with double angle brackets.
- F_2 and F_3 Lateral force acting in the joint between the component 2 and the component 1 in the component 2 direction. The component 2 shall be prevented from rotation. If the component 2 is prevented from rotation the load-carrying capacity will be half of a connection with double angle brackets.
- F_4 and F_5 Lateral force acting in the component 1 direction in the height of the top edge of component 2. F_4 is the lateral force towards the angle bracket; F_5 is the lateral force away from the angle bracket. Only the characteristic load-carrying capacities for angle brackets with ribs are given.

Wane

Wane is not allowed, the timber has to be sharp-edged in the area of the angle brackets.

Timber splitting

For the lifting force F_1 it must be checked in accordance with Eurocode 5 or a similar national Timber Code that splitting will not occur.

Combined forces

If the forces F_1 and F_2/F_3 or F_4/F_5 act at the same time, the following inequality shall be fulfilled:

$$\left(\frac{F_{1,d}}{F_{Rd,1}}\right)^2 + \left(\frac{F_{2,d}}{F_{Rd,2}}\right)^2 + \left(\frac{F_{3,d}}{F_{Rd,3}}\right)^2 + \left(\frac{F_{4,d}}{F_{Rd,4}}\right)^2 + \left(\frac{F_{5,d}}{F_{Rd,5}}\right)^2 \leq 1$$

The forces F_2 and F_3 or F_4 and F_5 are forces with opposite direction. Therefore only one force F_2 or F_3 , and F_4 or F_5 , respectively, is able to act simultaneously with F_1 , while the other shall be set to zero.

If the load F_4/F_5 is applied with an eccentricity e , a design for combined loading **for connections with double angle brackets** is required. Here, an additional force ΔF_1 has to be added to the existing force F_1 .

$$\Delta F_{1,d} = F_{4,d} / F_{5,d} \cdot \frac{e}{B}$$

B is the width of component 2.

Table B.1: Force F_1 Column, 2 angle brackets / connection

Bracket number	Bracket type	Nail number n_V	Nail number n_H	$F_{1,Rk}$ [kN] (column)	
				Timber	Steel
1131	70x70x55	1,2,3	12,13,14,15,16,20,21,22	3,15	1,84
1111	70x70x55 with rib	1,2,3	12,13,14,15,16,20,21,22	3,15	1,84
1132	90x90x65	1,2	10,11,12,13,15,16,17,19,20	5,00	2,77
1112	90x90x65 with rib	1,2	12,13,16,17,21,22	2,50	6,31
1133	105x105x90	1,2,4,5,6,8,10	18,19,20,21,22,23,26,27,28, 30,35,36	7,52	4,55
1113	105x105x90 with rib	1,2,4,5,6,7	14,15,16,17,20,21,27,28	5,01	15,8

Table B.2: Force F_1 Column, 1 angle bracket / connection

Bracket number	Bracket type	Nail number n_V	Nail number n_H	$F_{1,Rk}$ [kN] (column)	
				Timber	Steel
1131	70x70x55	1,2,3	12,13,14,15,16,20,21,22	1,58	0,92
1111	70x70x55 with rib	1,2,3	12,13,14,15,16,20,21,22	1,58	0,92
1132	90x90x65	1,2	10,11,12,13,15,16,17,19,20	2,50	1,38
1112	90x90x65 with rib	1,2	12,13,16,17,21,22	1,25	3,15
1133	105x105x90	1,2,4,5,6,8,10	18,19,20,21,22,23,26,27,28, 30,35,36	3,76	2,28
1113	105x105x90 with rib	1,2,4,5,6,7	14,15,16,17,20,21,27,28	2,51	7,91

Table B.3: Force F_1 Purlin, 2 angle brackets / connection

Bracket number	Bracket type	Nail number n_V	Nail number n_H	$F_{1,Rk}$ [kN] (purlin)	
				Timber	Steel
1131	70x70x55	1,2,3,7,8	12,13,14,15,16,20,21,22	3,15	1,84
1111	70x70x55 with rib	1,2,3,7,8	12,13,14,15,16,20,21,22	3,15	1,84
1132	90x90x65	1,2,4,5,6,7	10,11,12,13,15,16,17,19,20	5,00	2,77
1112	90x90x65 with rib	1,2,4,6,7,8,9	12,13,16,17,21,22	2,50	6,31
1133	105x105x90	1,2,4,5,6,8,10, 11,12,14,15	18,19,20,21,22,23,26,27,28,30, 35,36	7,52	4,55
1113	105x105x90 with rib	1,2,4,5,6,7,8, 9,10,11	14,15,16,17,20,21,27,28	5,01	15,8

Table B.4: Force F_1 Purlin, 1 angle bracket / connection

Bracket number	Bracket type	Nail number n_V	Nail number n_H	$F_{1,Rk}$ [kN] (purlin)	
				Timber	Steel
1131	70x70x55	1,2,3,7,8	12,13,14,15,16,20,21,22	1,58	0,92
1111	70x70x55 with rib	1,2,3,7,8	12,13,14,15,16,20,21,22	1,58	0,92
1132	90x90x65	1,2,4,5,6,7	10,11,12,13,15,16,17,19,20	2,50	1,38
1112	90x90x65 with rib	1,2,4,6,7,8,9	12,13,16,17,21,22	1,25	3,15
1133	105x105x90	1,2,4,5,6,8,10, 11,12,14,15	18,19,20,21,22,23,26,27, 28,30,35,36	3,76	2,28
1113	105x105x90 with rib	1,2,4,5,6,7,8, 9,10,11	14,15,16,17,20,21,27,28	2,51	7,91

Table B.5: Forces $F_{2,3}$, 2 angle brackets / connection

Bracket number	Bracket type	Nail number n_V	Nail number n_H	$F_{2,3,Rk}$ [kN]
				Timber
1131	70x70x55	1,2,3,7,8	12,13,14,15,16,20,21,22	5,80
1111	70x70x55 with rib	1,2,3,7,8	12,13,14,15,16,20,21,22	5,80
1132	90x90x65	1,2,4,5,6,7	10,11,12,13,15,16,17,19,20	7,34
1112	90x90x65 with rib	1,2,4,6,7,8,9	12,13,16,17,21,22	7,06
1133	105x105x90	1,2,4,5,6,8,10, 11,12,14,15	18,19,20,21,22,23,26,27,28,30,35,36	11,9
1113	105x105x90 with rib	1,2,4,5,6,7,8, 9,10,11	14,15,16,17,20,21,27,28	10,1

Table B.6: Forces $F_{2,3}$, 1 angle bracket / connection

Bracket number	Bracket type	Nail number n_V	Nail number n_H	$F_{2,3,Rk}$ [kN]
				Timber
1131	70x70x55	1,2,3,7,8	12,13,14,15,16,20,21,22	2,90
1111	70x70x55 with rib	1,2,3,7,8	12,13,14,15,16,20,21,22	2,90
1132	90x90x65	1,2,4,5,6,7	10,11,12,13,15,16,17,19,20	3,67
1112	90x90x65 with rib	1,2,4,6,7,8,9	12,13,16,17,21,22	3,53
1133	105x105x90	1,2,4,5,6,8,10, 11,12,14,15	18,19,20,21,22,23,26,27,28,30,35,36	5,94
1113	105x105x90 with rib	1,2,4,5,6,7,8, 9,10,11	14,15,16,17,20,21,27,28	5,06

Table B.7: Basic Forces $F_{4,5}$, 2 angle brackets / connection

Bracket number	Bracket type	Nail number n_V	Nail number n_H	$F_{4,5,Rk}$ [kN]	
				Timber	Steel
1131	70x70x55	1,2,3,7,8	12,13,14,15,16,20,21,22	5,34	4,34
1111	70x70x55 with rib	1,2,3,7,8	12,13,14,15,16,20,21,22	5,85	4,02
1132	90x90x65	1,2,4,5,6,7	10,11,12,13,15,16,17,19,20	7,82	4,45
1112	90x90x65 with rib	1,2,4,6,7,8,9	12,13,16,17,21,22	7,03	4,17
1133	105x105x90	1,2,4,5,6,8,10, 11,12,14,15	18,19,20,21,22,23,26,27,28,30, 35,36	9,30	8,46
1113	105x105x90 with rib	1,2,4,5,6,7,8, 9,10,11	14,15,16,17,20,21,27,28	9,96	13,1

Table B.8: Basic Forces F_4 , 1 angle bracket / connection

Bracket number	Bracket type	Nail number n_V	Nail number n_H	$F_{4,Rk}$ [kN]	
				Timber	Steel
1111	70x70x55 with rib	1,2,3,7,8	12,13,14,15,16,20,21,22	5,85	3,08
1112	90x90x65 with rib	1,2,4,6,7,8,9	12,13,16,17,21,22	7,03	3,66
1113	105x105x90 with rib	1,2,4,5,6,7,8, 9,10,11	14,15,16,17,20,21,27,28	9,96	9,21

Table B.9: Basic Forces F_5 , 1 angle bracket / connection

Bracket number	Bracket type	Nail number n_V	Nail number n_H	$F_{5,Rk}$ [kN]	
				Timber	Steel
1111	70x70x55 with rib	1,2,3,7,8	12,13,14,15,16,20,21,22	1,38	1,19
1112	90x90x65 with rib	1,2,4,6,7,8,9	12,13,16,17,21,22	1,98	1,17
1113	105x105x90 with rib	1,2,4,5,6,7,8, 9,10,11	14,15,16,17,20,21,27,28	2,95	4,82